

# ASSEMBLY INSTRUCTIONS



ITEM NUMBER: GEMMA-DR  
DESCRIPTION: DRESSER

Thank you for purchasing this quality product.



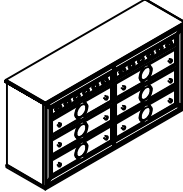

Please read instructions carefully prior to assembly.

Check carefully for small parts which may have come loose during transportation inside all the boxes. Remove from boxes and place all parts and components on soft surface such as carpet, blanket or furniture pad. Identify and verify all parts and hardware as specified below.

### PART LIST

No	Description	Outlook	Q.ty
A	Dresser		1
B	Legs		4
C	Center Legs		1

### Hardware List For Dresser-DR

No.	Description	Outlook	Size	Q.ty
1	Bolt		5/16"x4"	4
2	Spring washer		5/16"x1/2"	4
3	Flat washer		5/16"x3/4"	4
4	Allen Key		1/4"x3"	1
5	Straight Allen key		1/4"x4"	1

### DESCRIPTION

Tools Required (not provided)

Outlook

PHILLIPS SCREWDRIVER



### Assembly Tips:

-This assembly may require additional help (2 person set up)

-There is a tip restraint kit provided on the back of this product. please read the directions thoroughly an install immediately when placed in home

### STEP 1

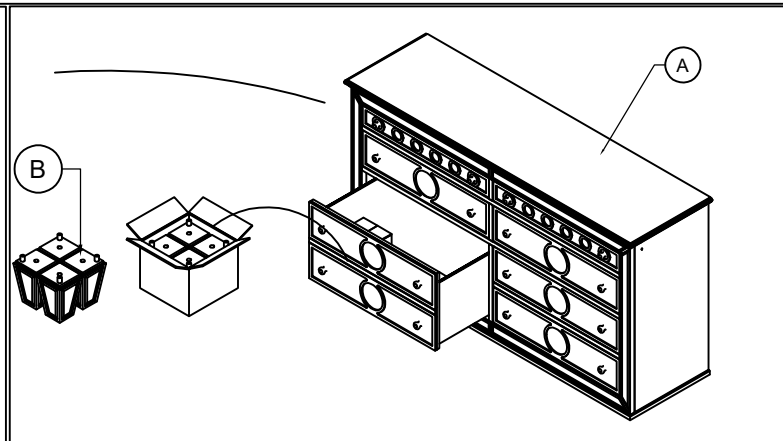
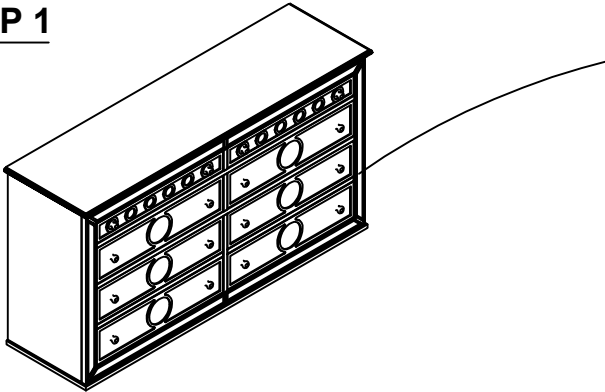

### STEP 2

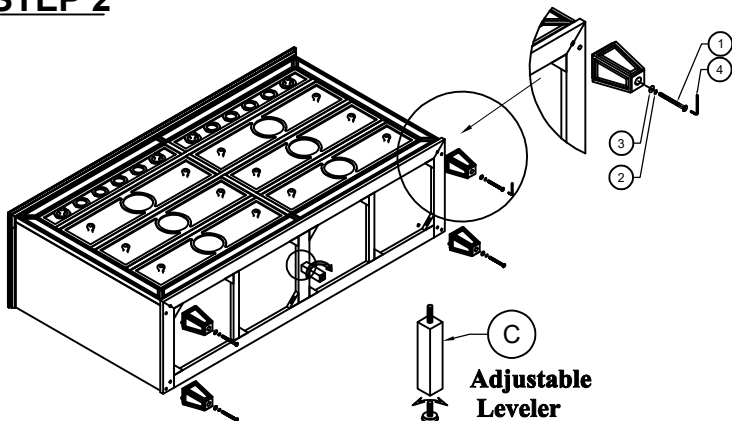

### STEP 3

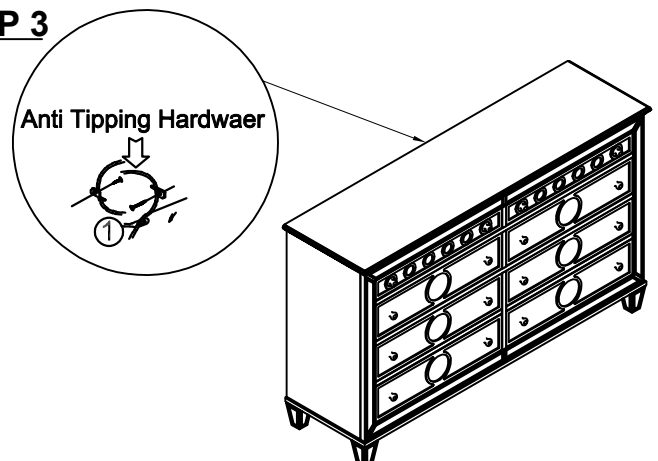

# ASSEMBLY INSTRUCTIONS

ITEM NUMBER: GEMMA-DR  
DESCRIPTION: DRESSER

## ADDITIONAL ASSEMBLY INFORMATION

ELECTRICAL CONNECTION DIAGRAM.

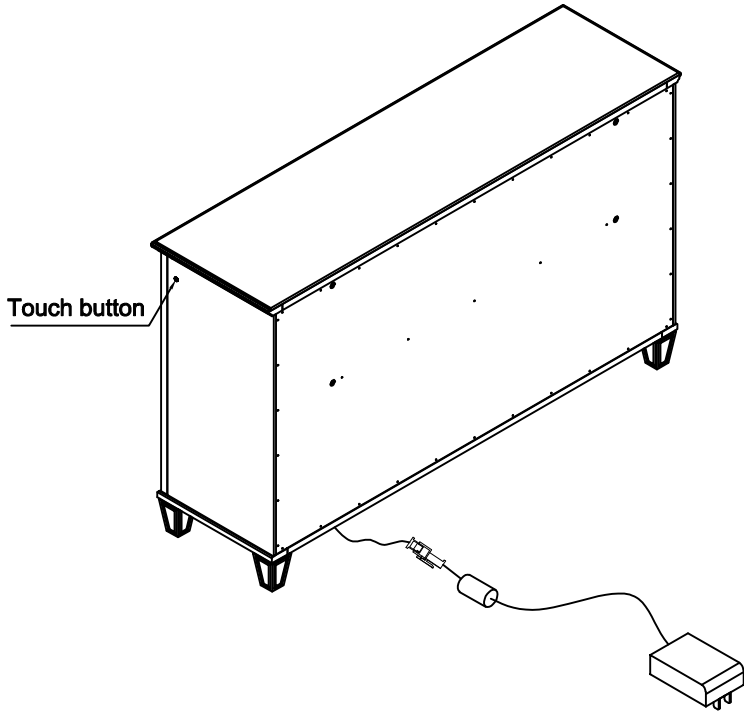

Assembly Completed

## ASSEMBLED PRODUCT SPECIFICATIONS AND DIMENSIONS

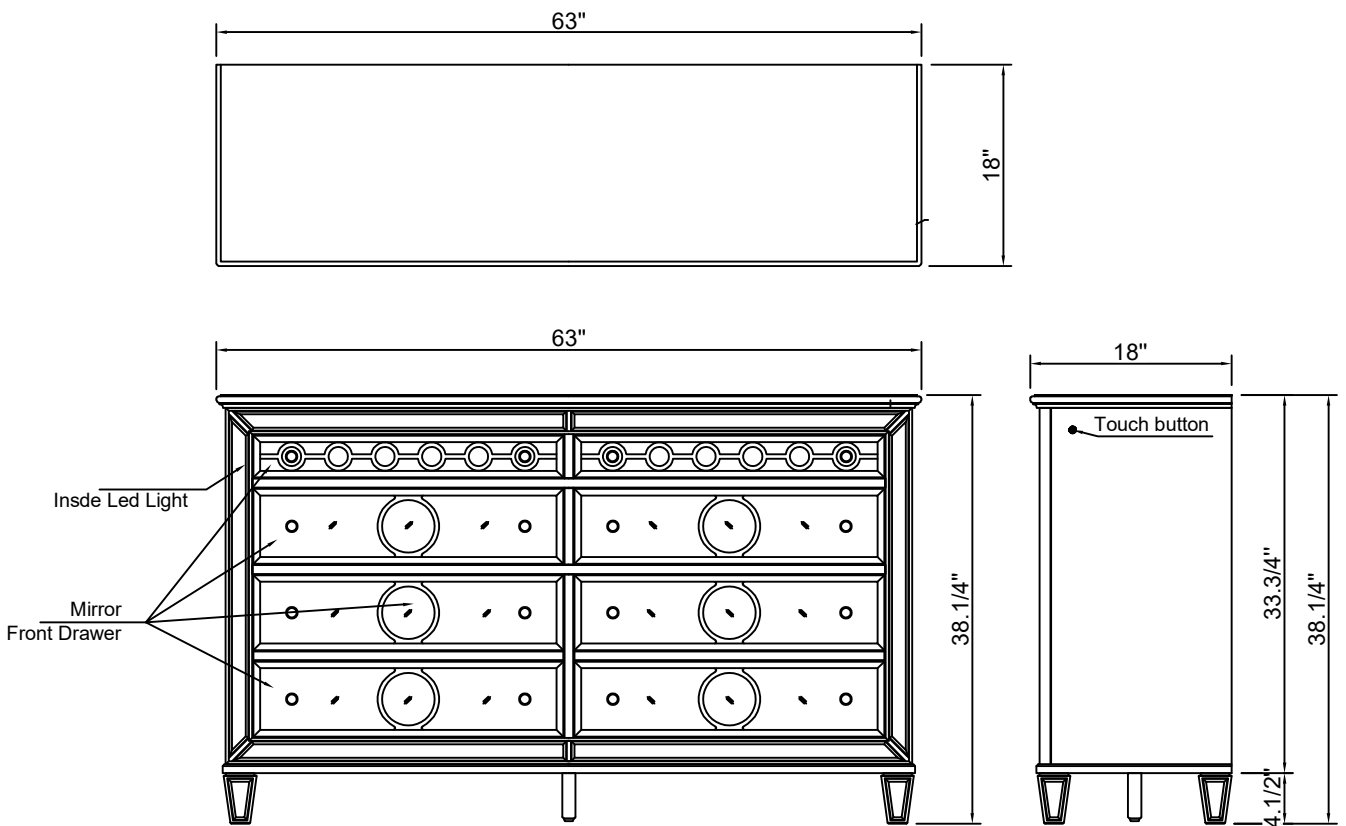

# ASSEMBLY INSTRUCTIONS

ITEM NUMBER: GEMMA-DR  
DESCRIPTION: DRESSER

**Caution:** Please read instructions thoroughly before unpacking assembly parts. Sharp exposed staple tips can cause injury, therefore, for your protection, please remove any exposed staples used in packing.

- 1 We recommend that you should assemble this product with the assistance of another person; this will make assembly easier, and will help to eliminate damage to the product or injury to persons during assembly
  - 2 Be sure to check all packing materials carefully for small parts that may have come loose inside the carton during shipment.
  - 3 Please do not over tighten screws or bolts
  - 4 Please put all parts on a non-abrasive floor before assembly, and follow the assembly steps to assemble your newly purchased product correctly and efficiently
- . Do not allow children to climb on furniture.
  - . Do not place television sets on top of chest, door chest, and/or dressers.
  - . Please place heaviest objects in the lowest drawers.
  - . Please have no more than one drawer open at a time.