

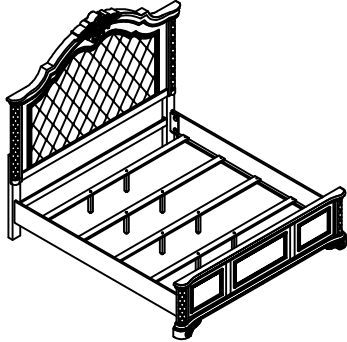









ASSEMBLY INSTRUCTION FOR





GROUP NO.: AMANI-KHB/KFB/R
DESCRIPTION: KING BED

Caution: Please read instructions thoroughly before unpacking assembly parts. Sharp, exposed staple tie can cause injury, therefore, for your protection, please remove any exposed staple used in packing.

1. We recommend that you should assemble this product with the assistance of another person;
2. Be sure to check all packing materials carefully for small parts that may have come loose inside the carton during shipment.
3. Please put all parts on a non-abrasive floor before assembly, and follow the assembly, and follow the assembly step to assemble your newly purchased product correctly and efficiently.

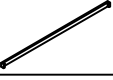
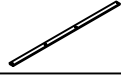
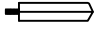

HARDWARE LIST				
NO.	DESCRIPTION	SKETCH	DIMENSION	Q'TY
1	BOLT		Φ5/16**45mm	8pcs
2	BOLT		Φ5/16**88mmL	8pcs
3	FLAT WASHER		Φ5/16**19mm	8pcs
4	SPRING WASHER		Ø5/16"	16pcs
5	CURVED WASHER		Ø5/16"	8pcs
6	NUT		Ø5/16"	8pcs
7	SCREW		8# * 32mmL	8pcs
8	ALLEN KEY		4mm	1pc
9	WRENCH		90*12mm	1pc

PART LIST			
NO.	DESCRIPTION	SKETCH	Q'TY
A	Headboard panel		1pc
B	Footboard		1pc
C	Headboard Leg(L&R)		2pcs
D	Headboard Cross Bar		1pc
E	Slats		4pcs
F	Support leg for center slat		8pcs
G	Side Rails		2pcs

Step 1

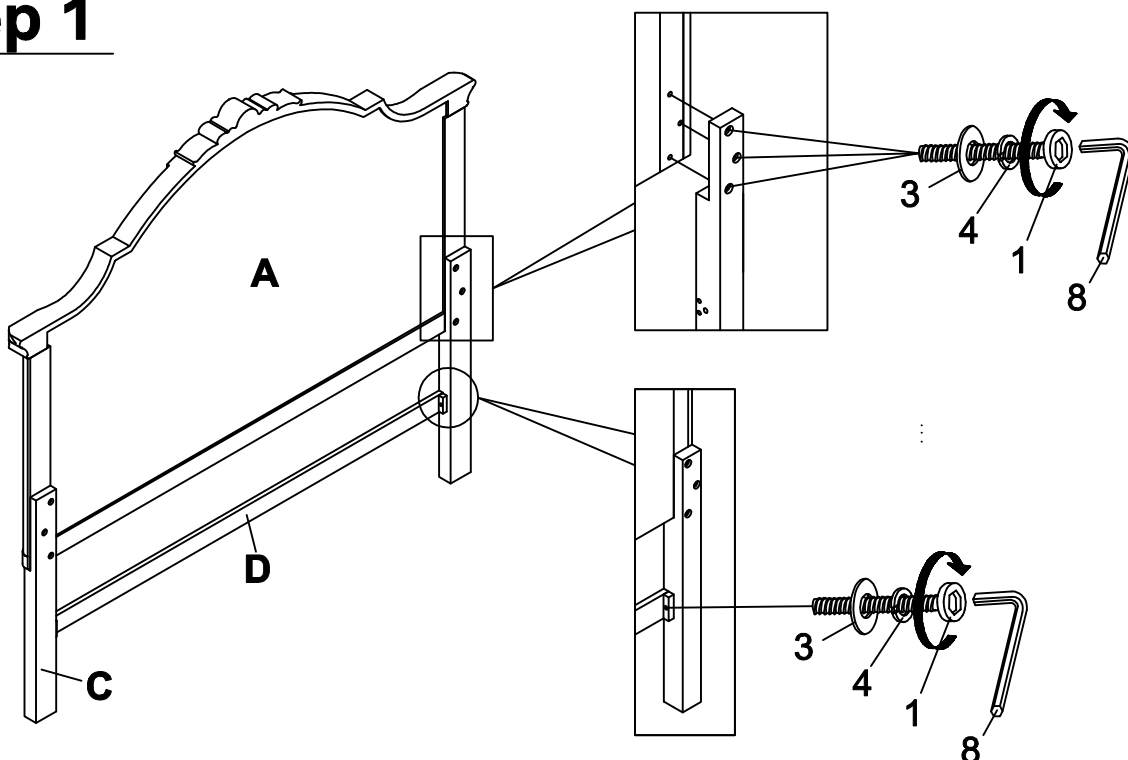

Caution: Please read instructions thoroughly before unpacking assembly parts. Sharp, exposed staple tie can cause injury, therefore, for your protection, please remove any exposed staple used in packing.

1. We recommend that you should assemble this product with the assistance of another person;
2. Be sure to check all packing materials carefully for small parts that may have come loose inside the carton during shipment.
3. Please put all parts on a non-abrasive floor before assembly, and follow the assembly, and follow the assembly step to assemble your newly purchased product correctly and efficiently.

Step 2

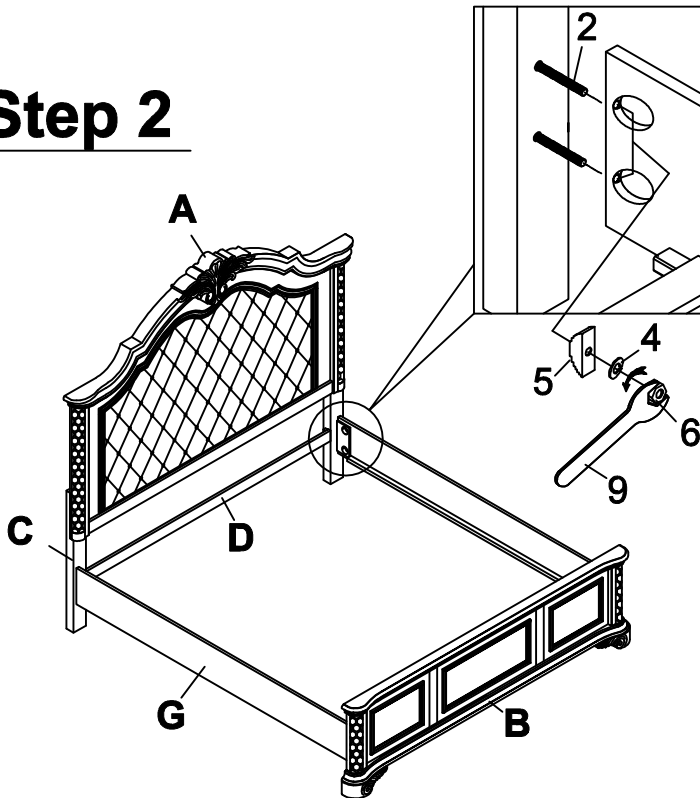

Step 3

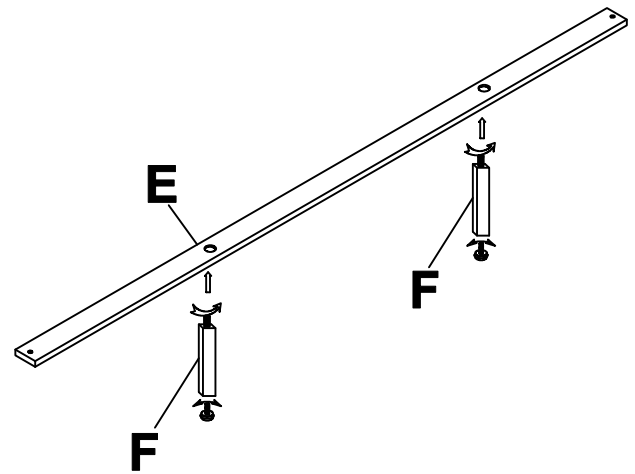

Step 4

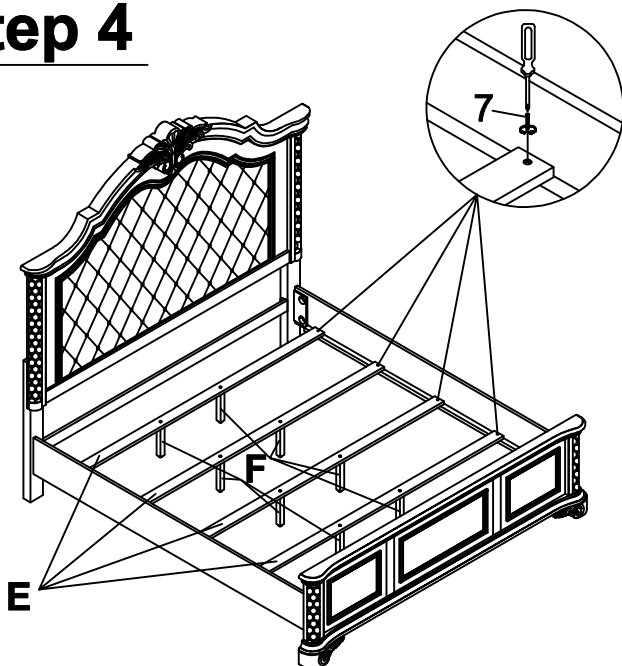

Step 5

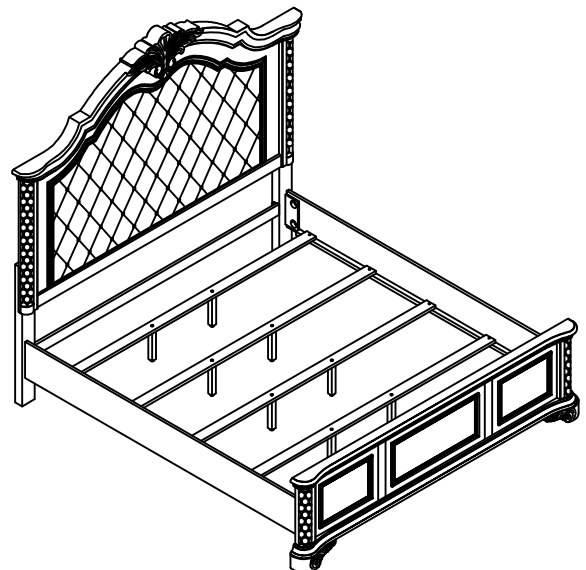

Completed